

Unidad: **ADMINISTRACIÓN CENTRAL**

DEPENDENCIA: **HOSPITAL GENERAL DE TORREÓN**

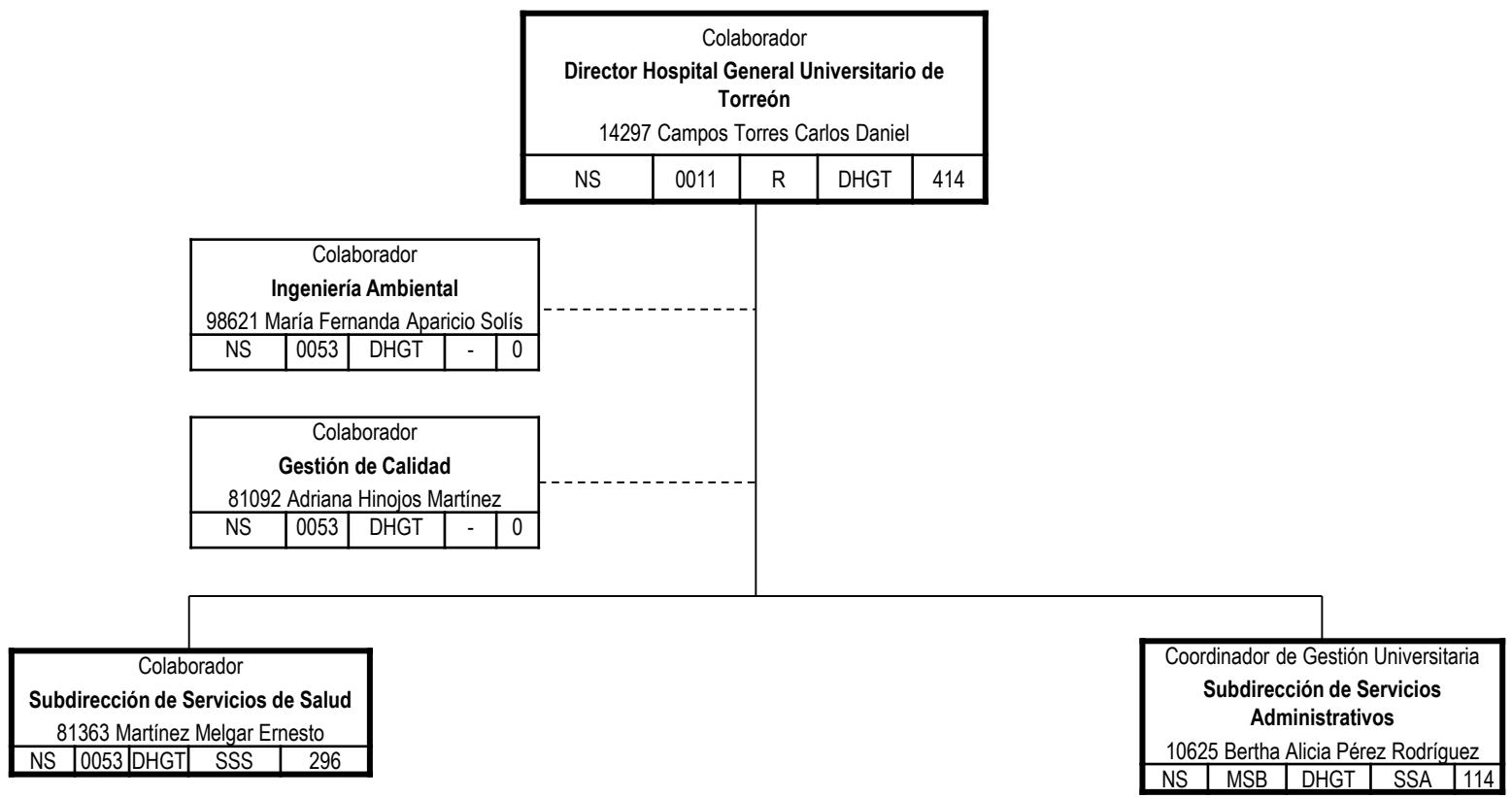



Unidad: **ADMINISTRACIÓN CENTRAL**

DEPENDENCIA: **HOSPITAL GENERAL DE TORREÓN**

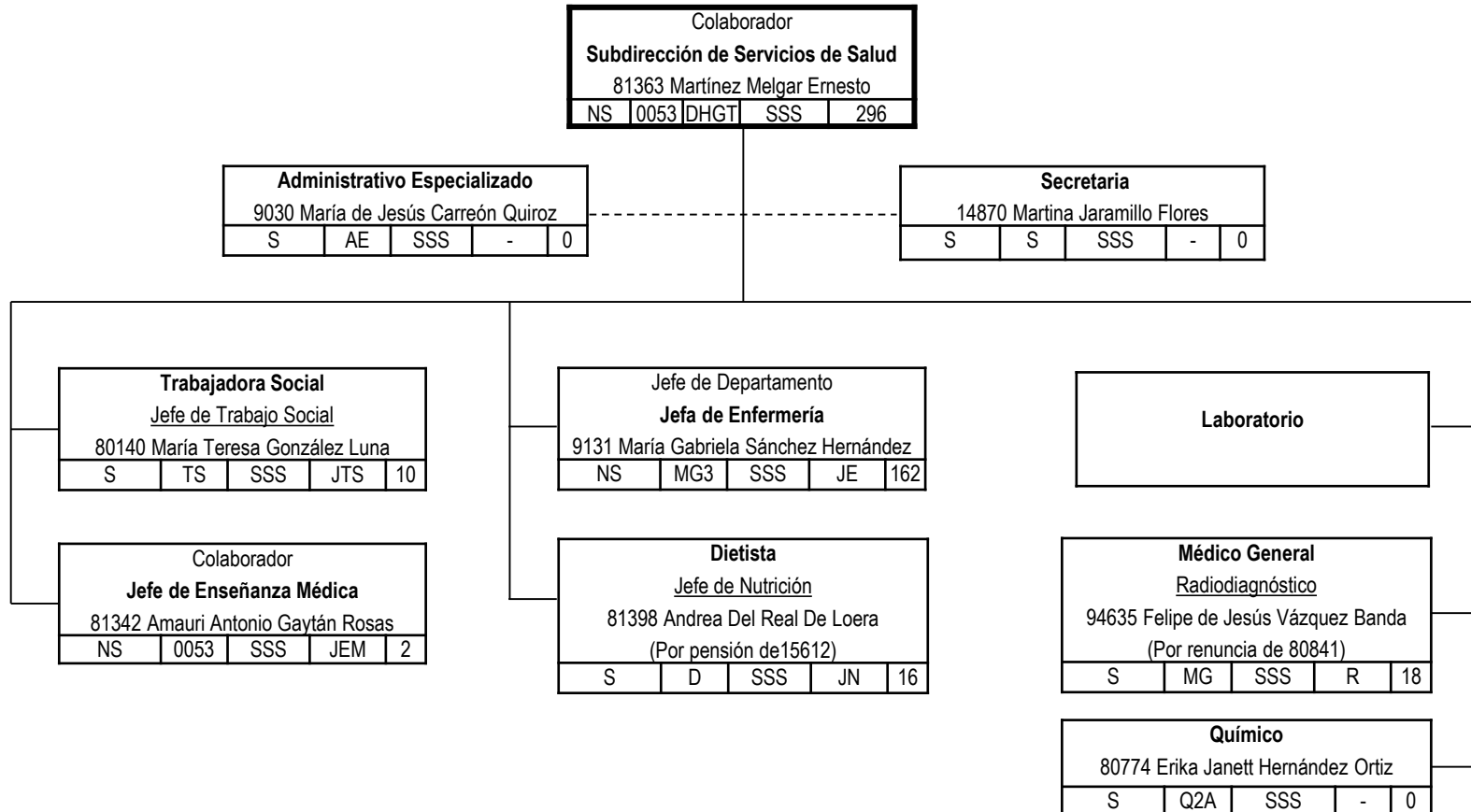

Unidad: **ADMINISTRACIÓN CENTRAL**

DEPENDENCIA: **HOSPITAL GENERAL DE TORREÓN**

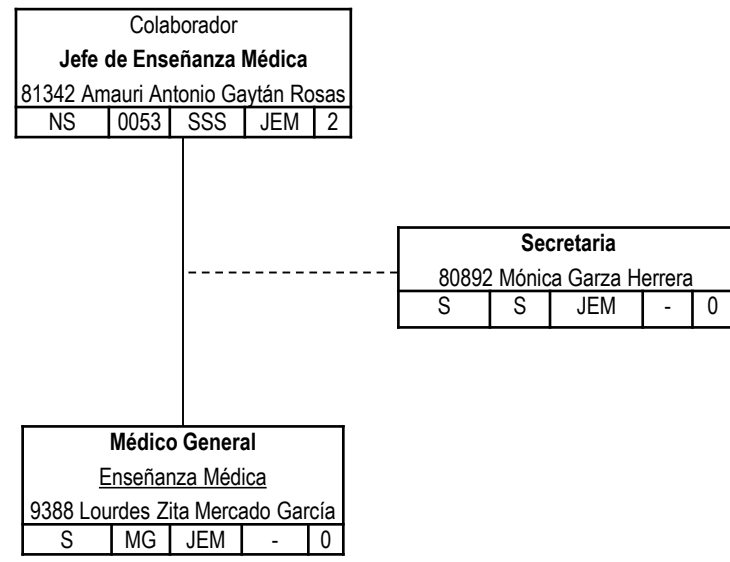

Unidad: **ADMINISTRACIÓN CENTRAL**

DEPENDENCIA: **HOSPITAL GENERAL DE TORREÓN**

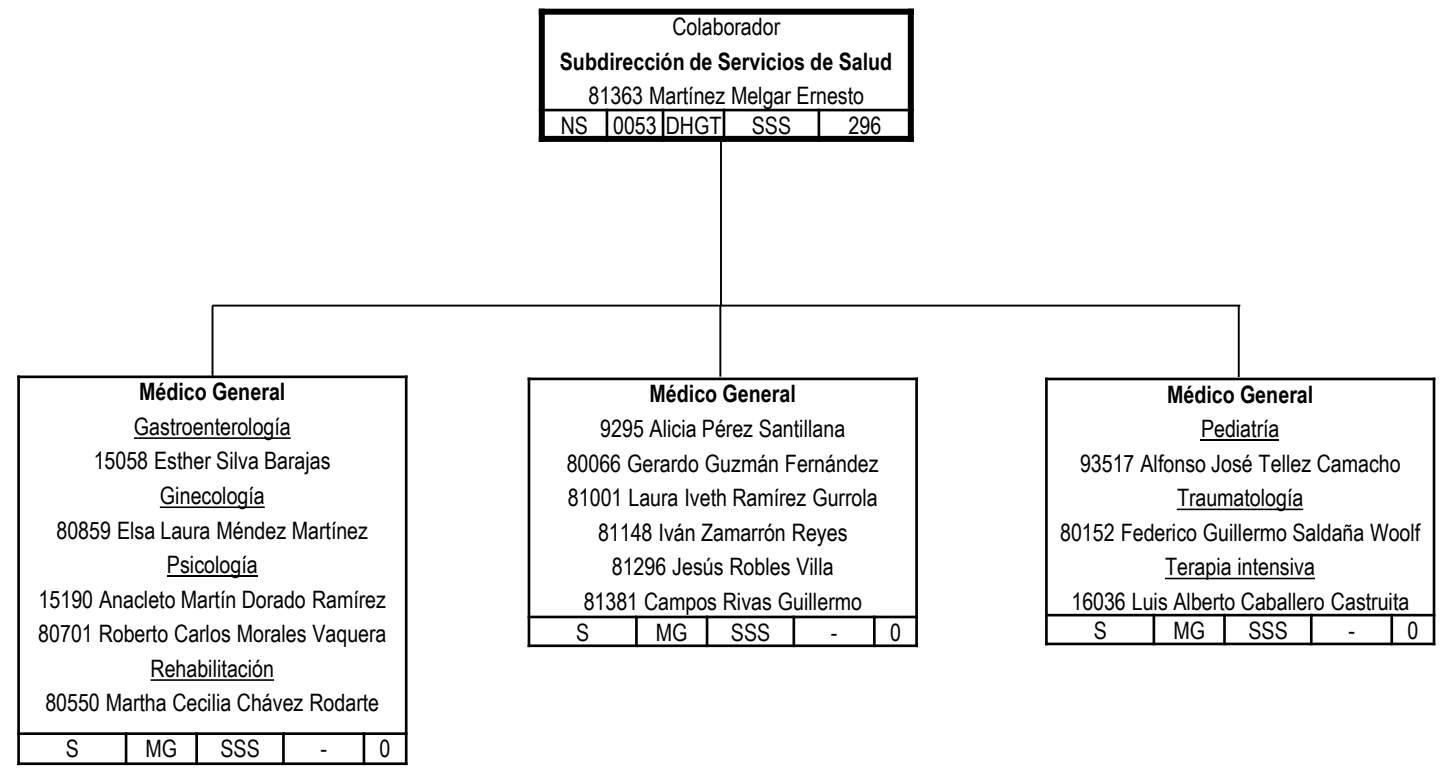

Unidad: **ADMINISTRACIÓN CENTRAL**

DEPENDENCIA: **HOSPITAL GENERAL DE TORREÓN**

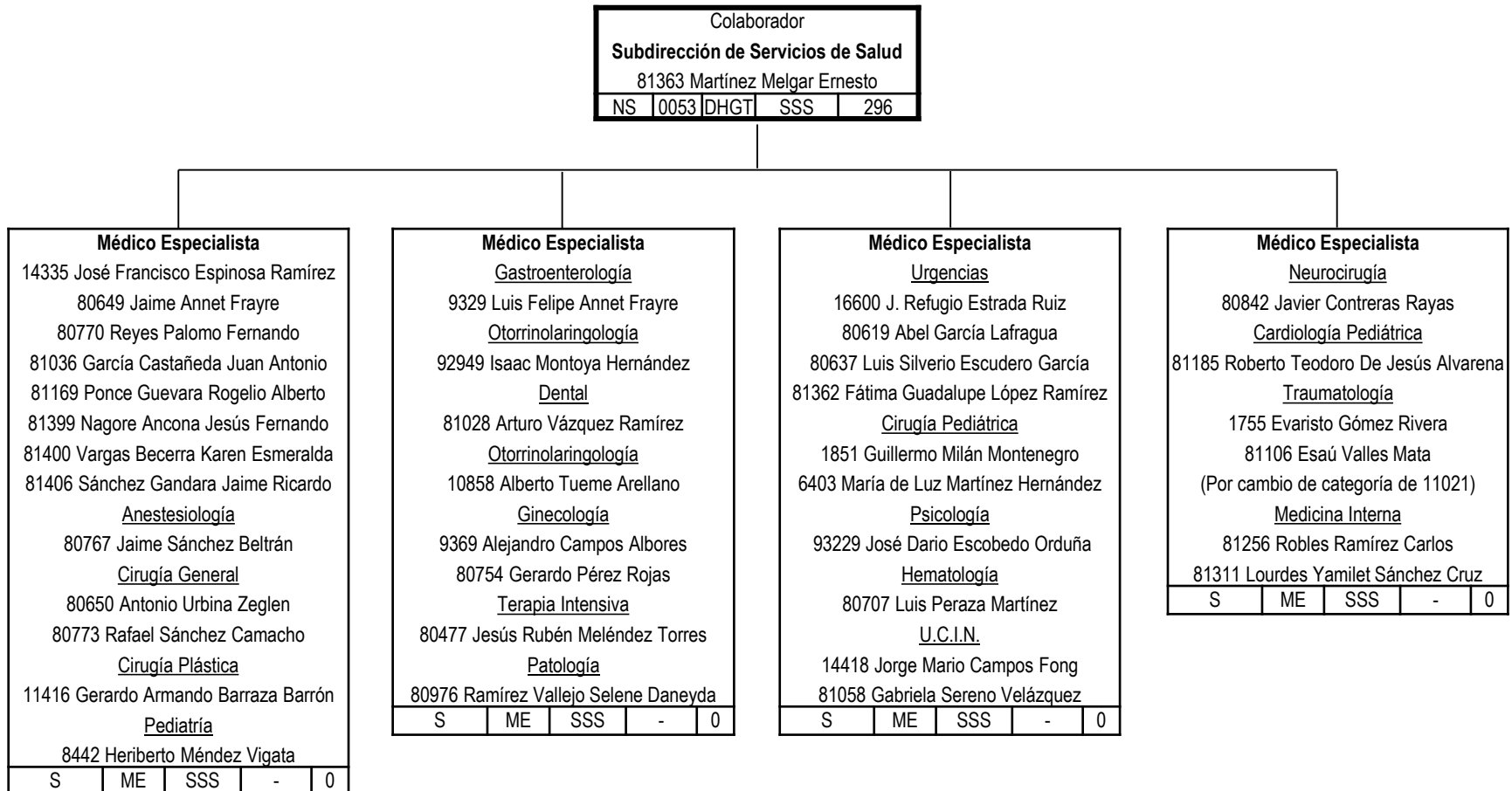

Unidad: **ADMINISTRACIÓN CENTRAL**

DEPENDENCIA: **HOSPITAL GENERAL DE TORREÓN**

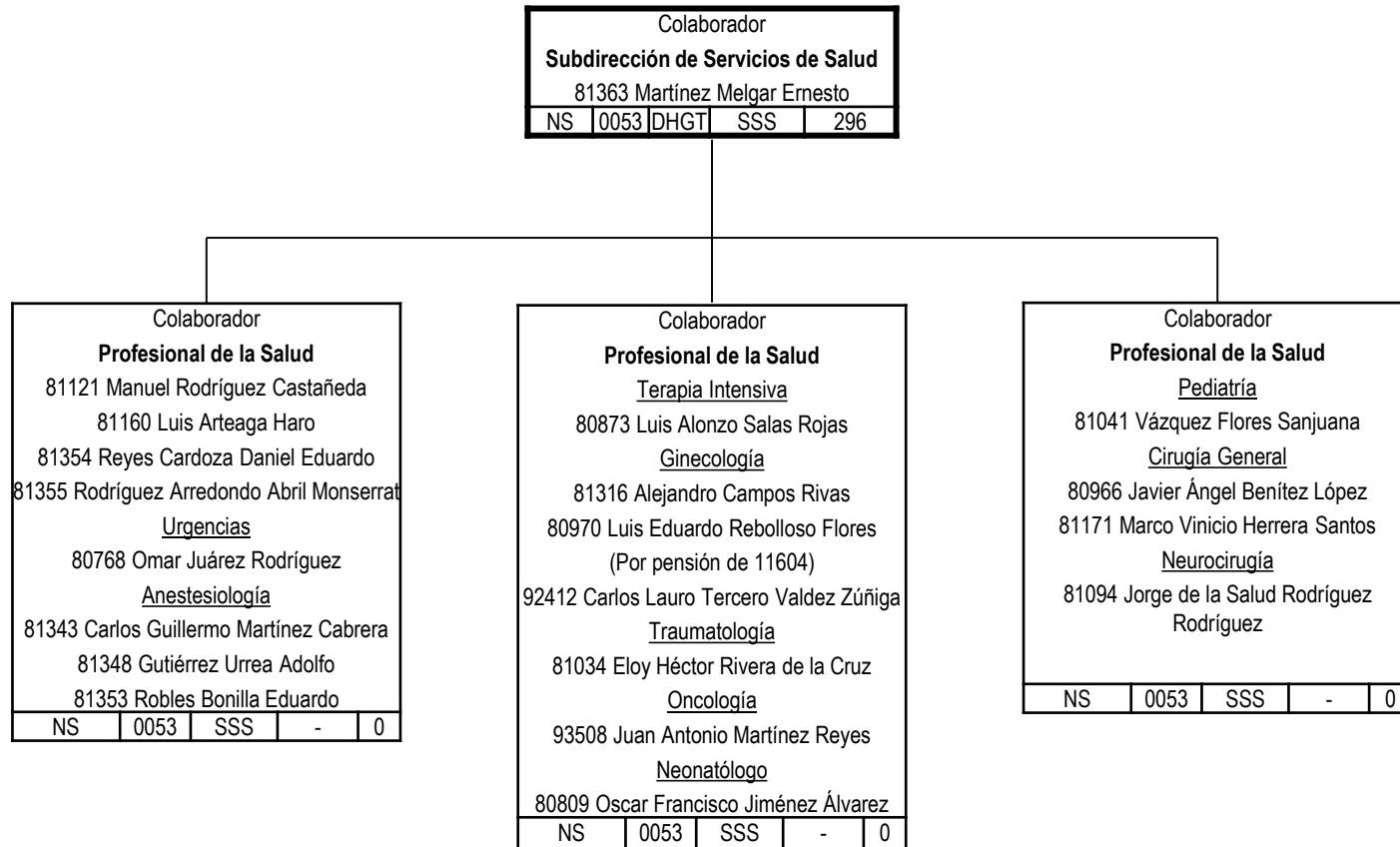



Unidad: **ADMINISTRACIÓN CENTRAL** Dependencia: **HOSPITAL GENERAL UNIVERSITARIO DE TORREÓN**

Trabajadora Social				
<u>Jefe de Trabajo Social</u>				
80140 María Teresa González Luna				
S	TS	SSS	JTS	10

Trabajador Social en área médica				
14880 Beatriz Carreón Quiroz				
80041 Olga Lidia González Bocanegra				
80105 Griselda Castro Hernández				
80191 Bertha Alicia Lazalde Tapia				
80200 Concepción Ortiz Amador				
80248 María de Jesús Martínez Ávila				
80692 Ana Cecilia Zuñiga García				
80775 María Guadalupe López Torres				
80898 Rosa Otilia Martínez Hernández				
VACANTE (Por pensión de 14165)				
VACANTE (por pensión temporal de 80054)				
<u>Admisión</u>				
14871 Alma Olivia Hidalgo Carreón				
S	TS	JTS	-	0



Unidad: **ADMINISTRACIÓN CENTRAL** Dependencia: **HOSPITAL GENERAL UNIVERSITARIO DE TORREÓN**

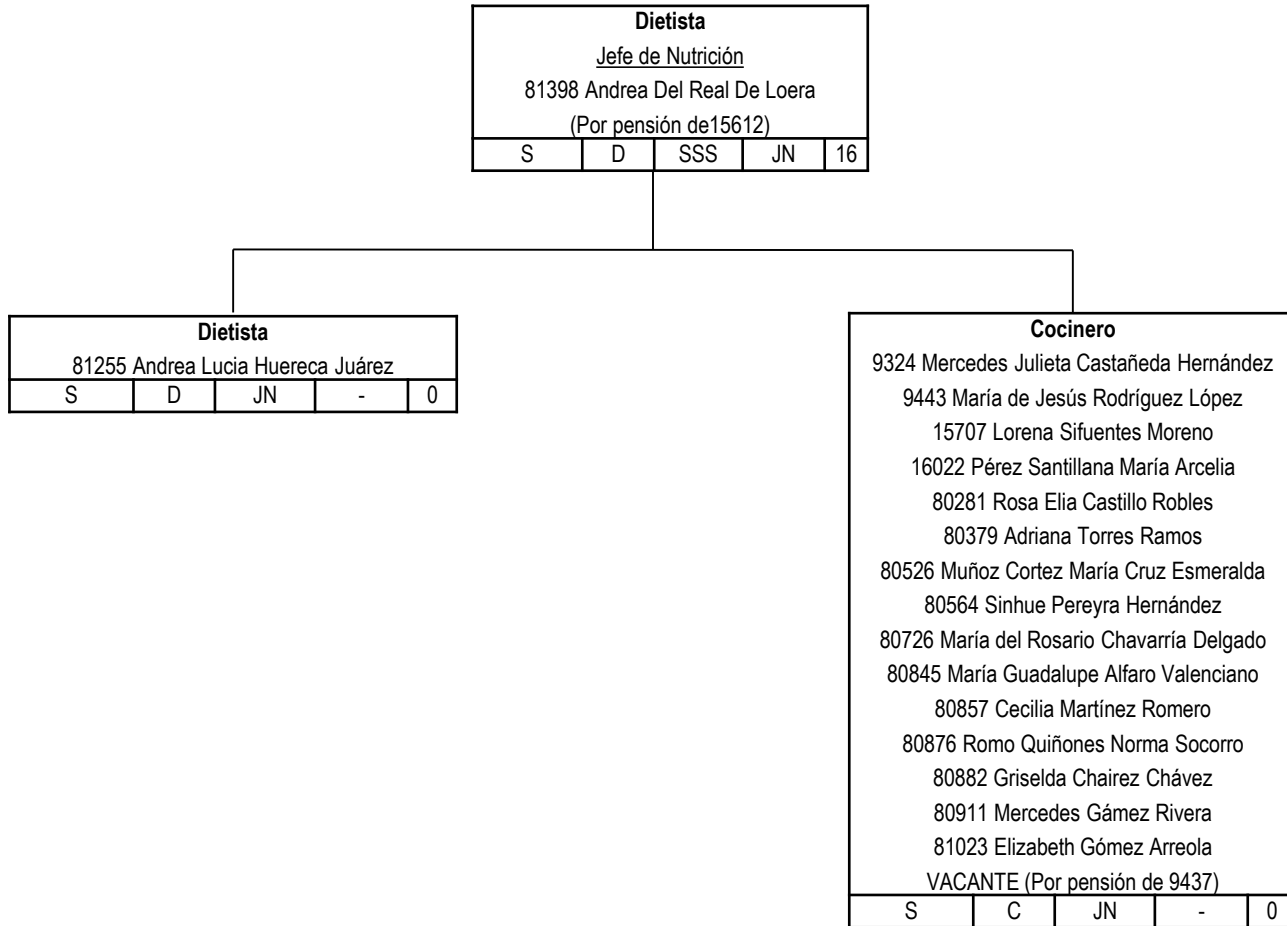



Unidad: **ADMINISTRACIÓN CENTRAL** Dependencia: **HOSPITAL GENERAL UNIVERSITARIO DE TORREÓN**

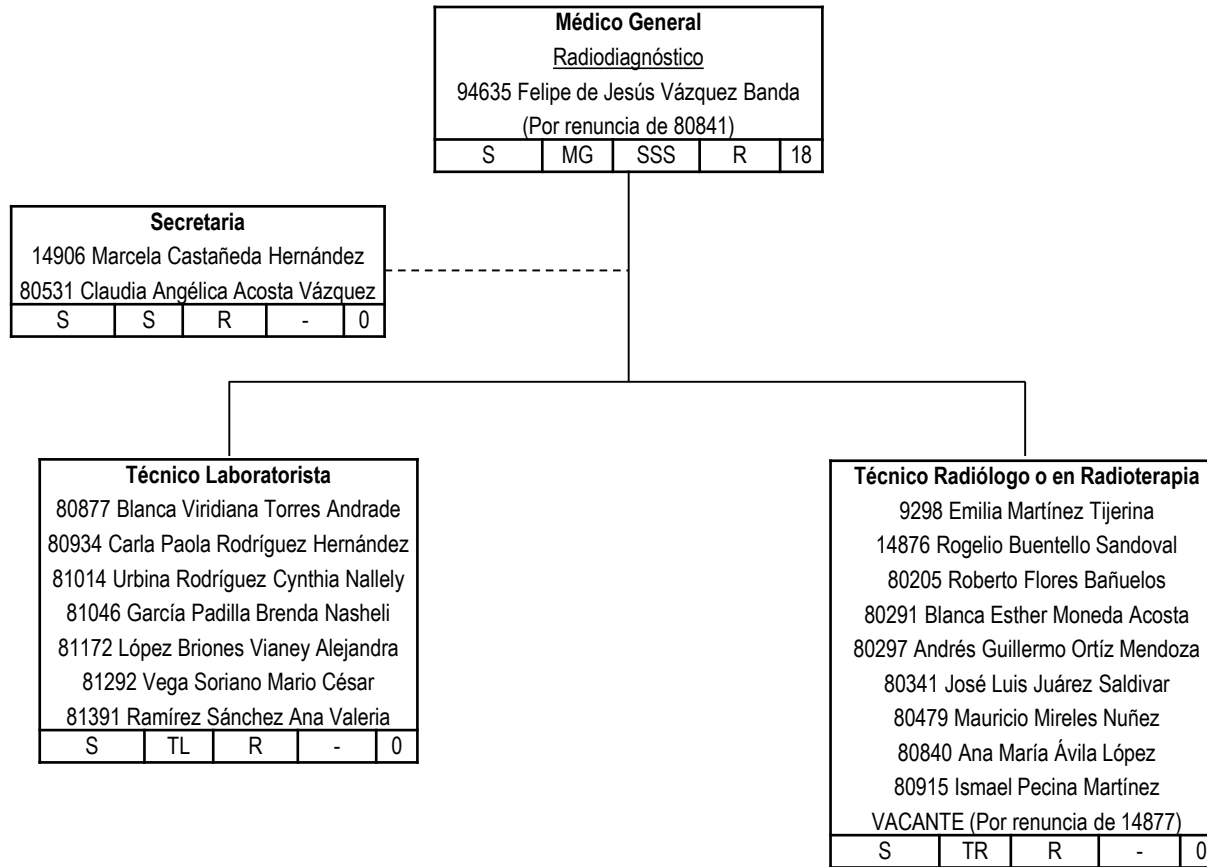



Unidad: **ADMINISTRACIÓN CENTRAL** Dependencia: **HOSPITAL GENERAL UNIVERSITARIO DE TORREÓN**

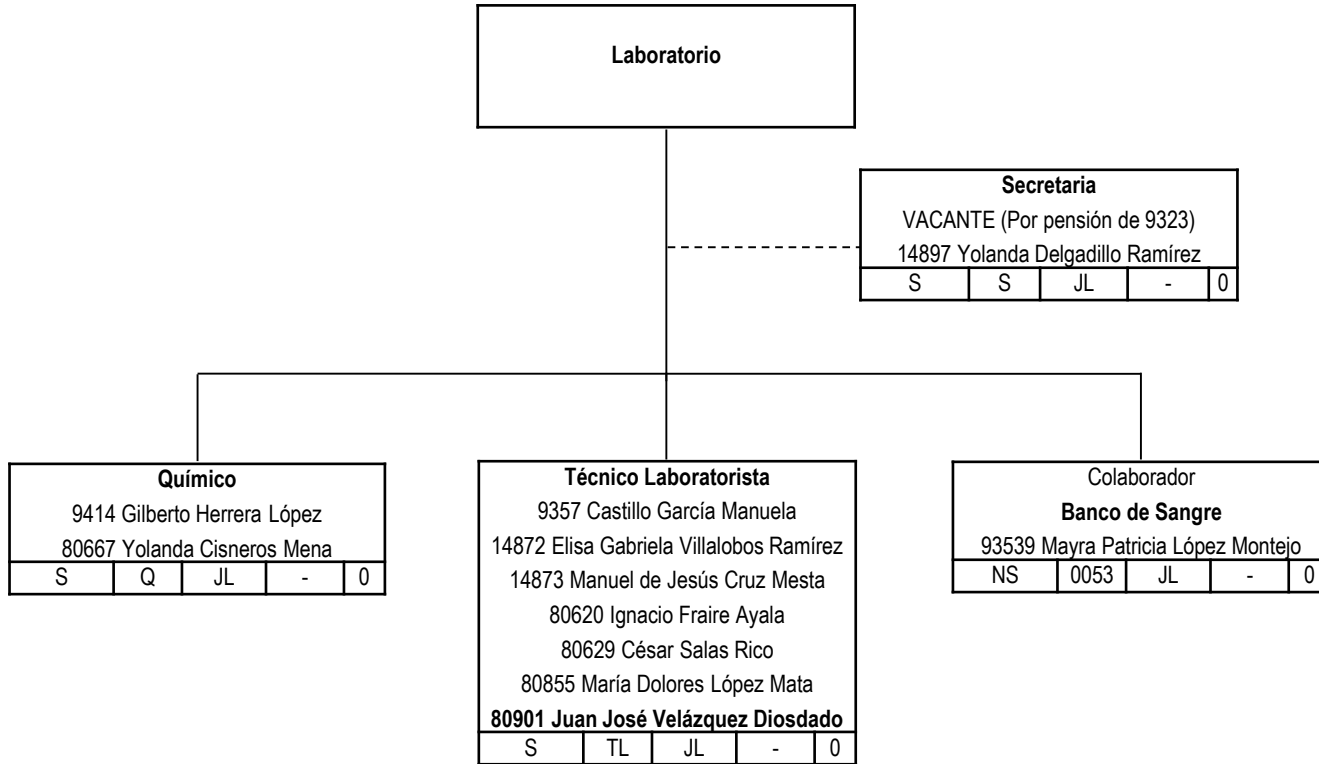

Unidad: **ADMINISTRACIÓN CENTRAL**

DEPENDENCIA: **HOSPITAL GENERAL DE TORREÓN**

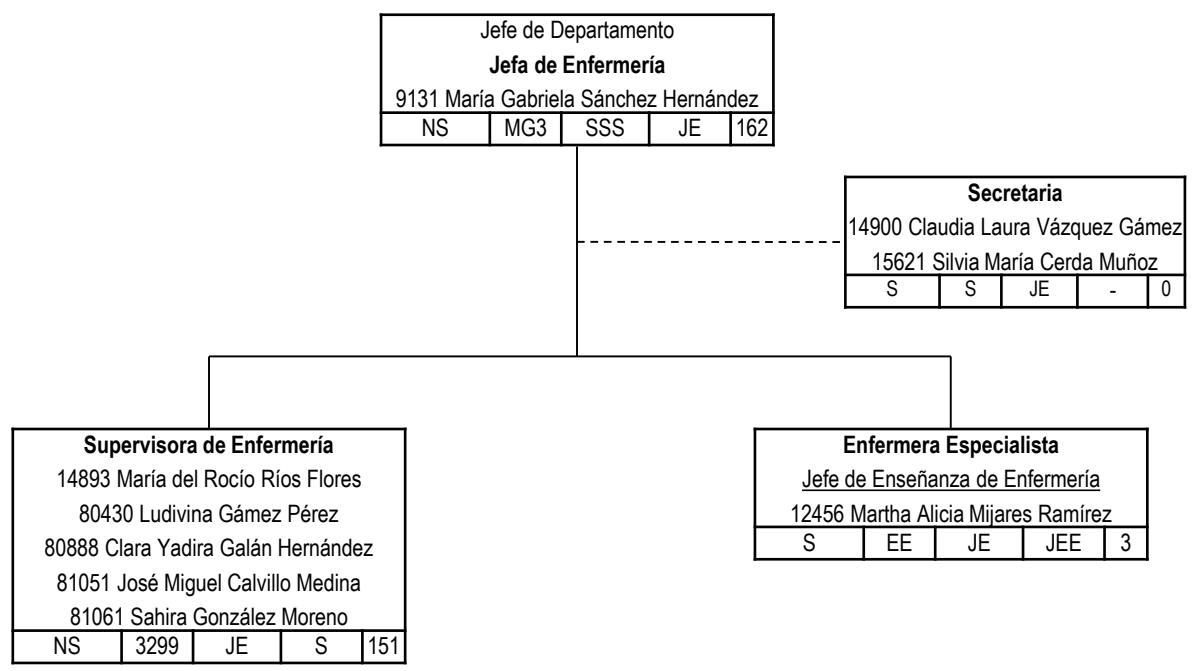

Unidad: **ADMINISTRACIÓN CENTRAL**

DEPENDENCIA: **HOSPITAL GENERAL DE TORREÓN**

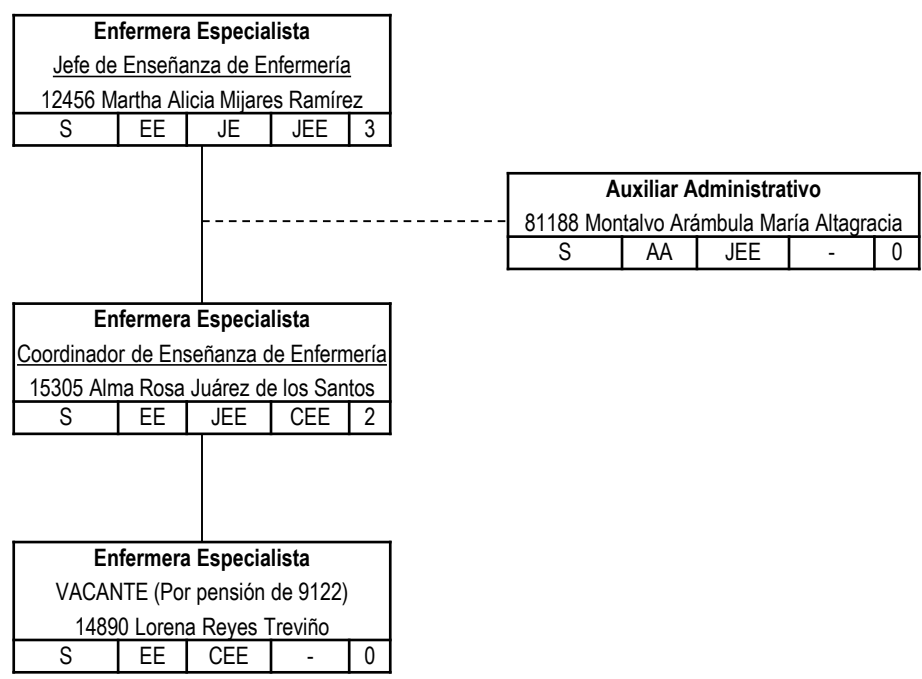

Unidad: **ADMINISTRACIÓN CENTRAL**

DEPENDENCIA: **HOSPITAL GENERAL DE TORREÓN**

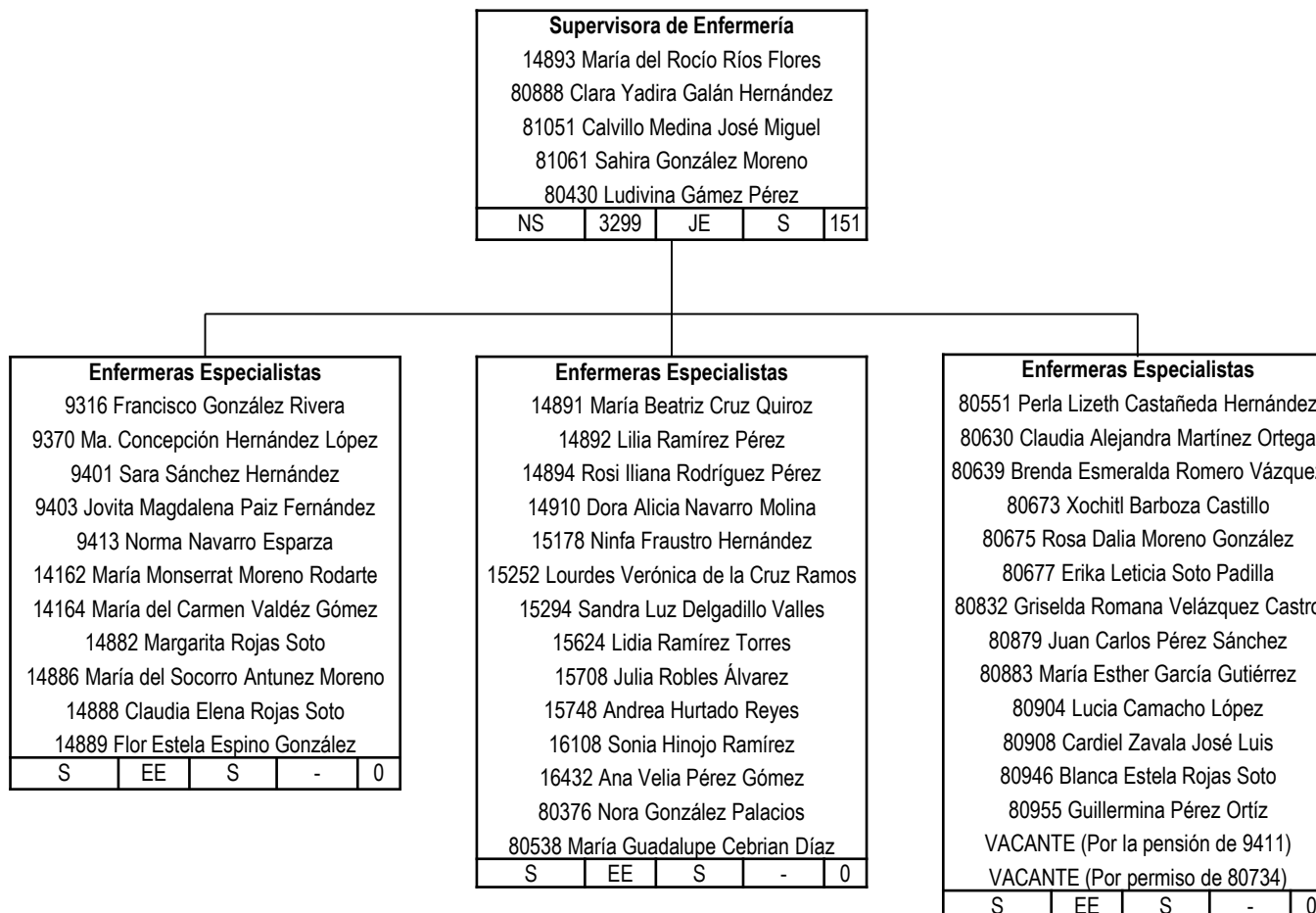



Unidad: **ADMINISTRACIÓN CENTRAL** Dependencia: **HOSPITAL GENERAL UNIVERSITARIO DE TORREÓN**

Supervisora de Enfermería				
14893 María del Rocío Ríos Flores				
80888 Clara Yadira Galán Hernández				
81051 Calvillo Medina José Miguel				
81061 Sahira González Moreno				
80430 Ludivina Gámez Pérez				
NS	3299	JE	S	151

Enfermera General				
9321 Verónica Castro Holguin				
9389 Daniel Gerardo Lira Alvarado				
9400 María Esthela Salgado López				
9412 Olivia Moran Bernal				
13924 Ma. Esperanza Rentería Soto				
13925 Patricia González Salas				
14158 Norma Catalina Domínguez Rodríguez				
14884 Bertha Alicia Díaz Ciseña				
14895 Margarito González Martínez				
15184 Beatriz Favela Delgado				
15278 Silvia Angélica Castillo Villarreal				
S	EG	S	-	0

Enfermera General				
15304 Charon Navarro Molina				
15623 Verónica Ruelas Montelongo				
16003 Verónica Hernández Reveles				
36221 Delia Mariana Hernández Coronado				
80398 Carmen Evelia Castor Treviño				
80507 María del Socorro Peralta Arroyo				
80528 Dulce Mayela Moreno Rodarte				
80644 Liz Yamal Molina Martell				
80647 Andrea Villegas López				
80659 María Antonieta Quintero López				
80676 Erika Gabriela Álvarez López				
80680 Yasmín Avilés de León				
80684 Perla Aide Orona Álvarez				
S	EG	S	-	0

Enfermera General				
80738 Hernández Garay Edith Guadalupe				
80834 Olga Minerva Castelo Martínez				
80853 Dina Alejandra Gámez Pérez				
80871 Sandoval Soria Lizeth Argelia				
80887 Recio de Luna Carolina				
80903 Claudia Castelo Martínez				
80909 Reynalda Guadalupe de Ávila Vázquez				
80921 Parra Gurrola Miguel				
80923 Gabriela Margarita López Aparicio				
80925 San Juana Herrera González				
80947 América Vanessa Valencia Ramos				
S	EG	S	-	0

Enfermera General				
80948 Jesús Eduardo Hernández Cisneros				
80949 Claudia Gabriela Rojas Veles				
80950 Gabriela Elizabeth Martínez de Ávila				
VACANTE (Por renuncia de 80951)				
80957 Montes Pacheco Gabriela Ivonne				
80974 María Elena Delgado Nava				
80975 Clara Torres González				
80978 García Zapata Gonzalo Alejandro				
80979 Nohemí Quintero López				
80981 Castruita Alvarado Daniel				
81012 Daniela Rangel Santana				
81013 Reberte García Roberto Carlos				
81015 Tania Chaires Borroel				
81016 Claudia Janeth Rivera Gutiérrez				
S	EG	S	-	0



Unidad: **ADMINISTRACIÓN CENTRAL** Dependencia: **HOSPITAL GENERAL UNIVERSITARIO DE TORREÓN**

Supervisora de Enfermería				
14893 María del Rocío Ríos Flores				
80888 Clara Yadira Galán Hernández				
81051 Calvillo Medina José Miguel				
81061 Sahira González Moreno				
80430 Ludivina Gámez Pérez				
NS	3299	JE	S	151

Enfermera General				
81018 Alejandra Tepezano Portillo				
81030 Sanjuana Espino Gutiérrez				
81031 Isidra Villegas García				
81052 Alejandra Moreno Puentes				
81060 Perla Marisela Ramírez Tovar				
81062 Susana Hernández Cortinas				
81066 Emily Aguirre Martínez				
81068 Alberto González Quiñones				
81101 Pérez Reyes Michael Eduwiges				
81102 Beatriz Adriana Olvera Rentería				
81105 Morales Segura Laura Liliana				
81110 Vázquez Avalos Fabiola				
81111 Manuel Alejandro Navarro Ochoa				
81142 Perla Madolina Peinado Arenivar				
81143 María Monserrat Hernández Gómez				
S	EG	S	-	0

Enfermera General				
81145 Murillo Castro Jazmin Sarahi				
81147 Beltrán López Benigno				
81157 Rosas Hernández Cindy Lisseth				
81177 Blanca Patricia Aguilar Solís				
81178 Kendy Guadalupe Reyes Espino				
81180 Pedro Alberto Méndez Méndez				
81190 Marycruz Chairez Rodríguez				
81202 Claudia Yadira Ibarra López				
81217 Dania Elisa González Domínguez				
81226 Larissa Castañón Escareño				
81235 Alma Delia Mata Lara				
81236 Carmen Guadalupe Chapa Gaona				
81305 Castro Ramírez Axel Alfredo				
81365 García Torres Jéssica Guadalupe				
81366 Saldaña Hernández Diana Jacqueline				
81367 Gueta Alcántar Deisy Yuliana				
81377 Alcalá Fraire Eduardo Alejandro				
81387 Guerrero Plata Jhonatan Eliu				
(Por pensión de 9318)				
90360 Fabiola Navarro Hernández				
S	EG	S	-	0

Enfermera General				
VACANTE (Por permiso de 81104)				
VACANTE (Por pensión de 9353)				
VACANTE (Por pensión de 14161)				
VACANTE (Por renuncia de 80836)				
VACANTE (Por permiso de 81136)				
VACANTE (Por c.c.de 14893)				
VACANTE (Por pensión de 7964)				
VACANTE (Por permiso de 71946)				
VACANTE (Por permiso de 81063)				
VACANTE (Por permiso de 81064)				
VACANTE (Por permiso de 81141)				
VACANTE (Por permiso de 81146)				
S	EG	S	-	0



Unidad: **ADMINISTRACIÓN CENTRAL** Dependencia: **HOSPITAL GENERAL UNIVERSITARIO DE TORREÓN**

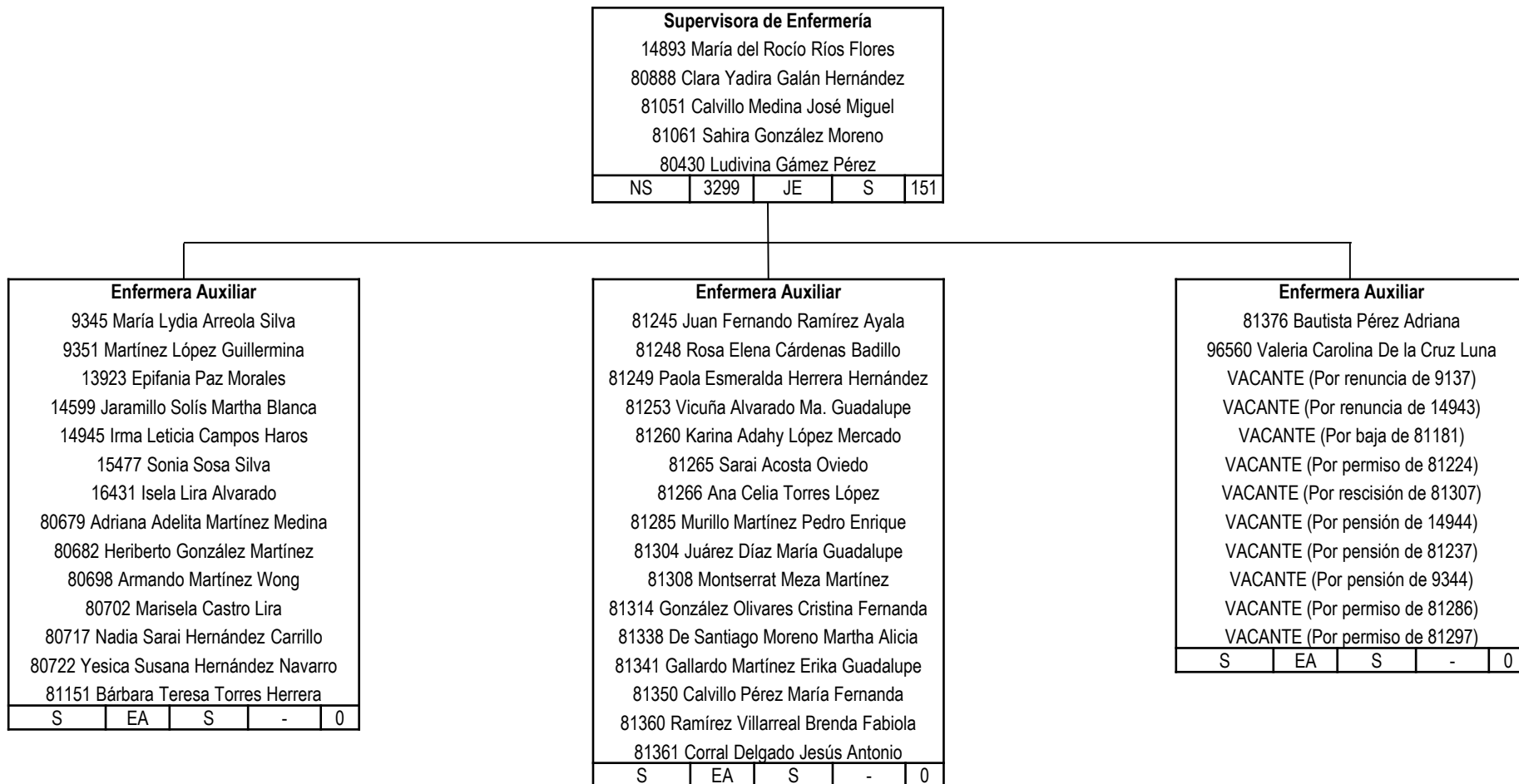

Unidad: **ADMINISTRACIÓN CENTRAL**

DEPENDENCIA: **HOSPITAL GENERAL DE TORREÓN**

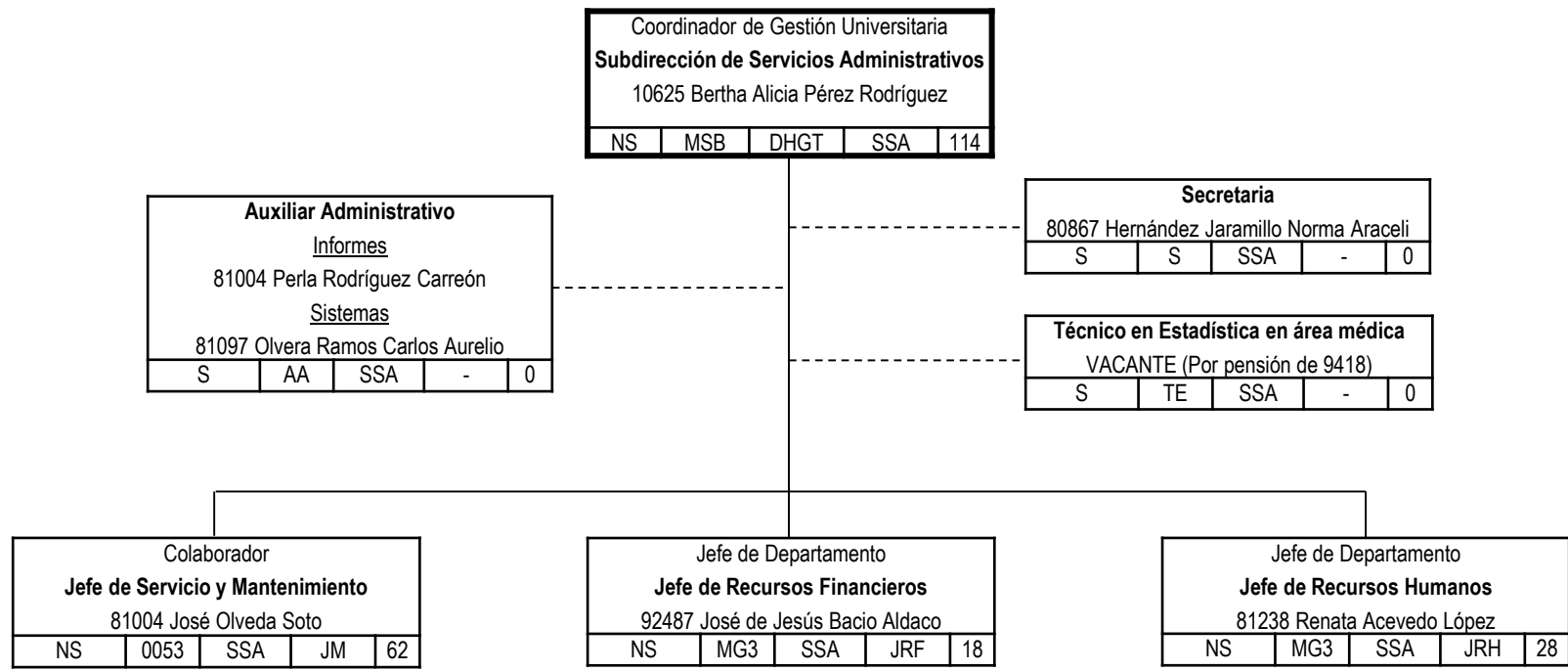

Unidad: **ADMINISTRACIÓN CENTRAL**

DEPENDENCIA: **HOSPITAL GENERAL DE TORREÓN**

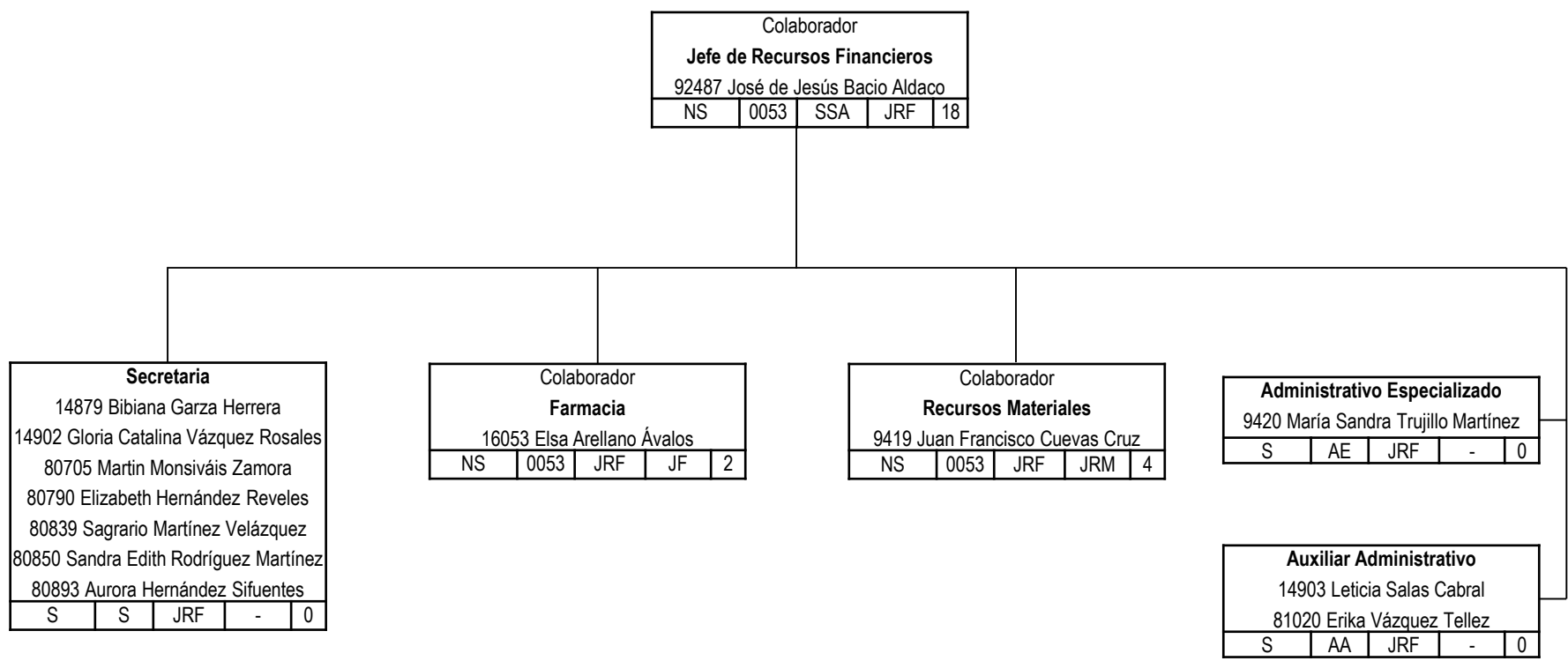

Unidad: **ADMINISTRACIÓN CENTRAL**

DEPENDENCIA: **HOSPITAL GENERAL DE TORREÓN**

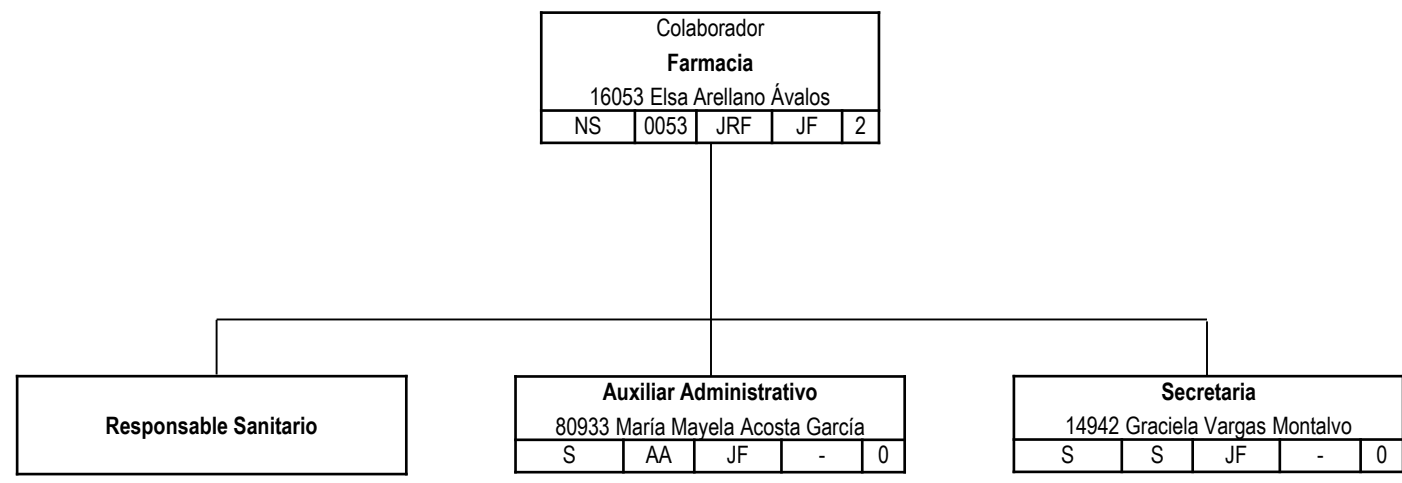

Unidad: **ADMINISTRACIÓN CENTRAL**

DEPENDENCIA: **HOSPITAL GENERAL DE TORREÓN**

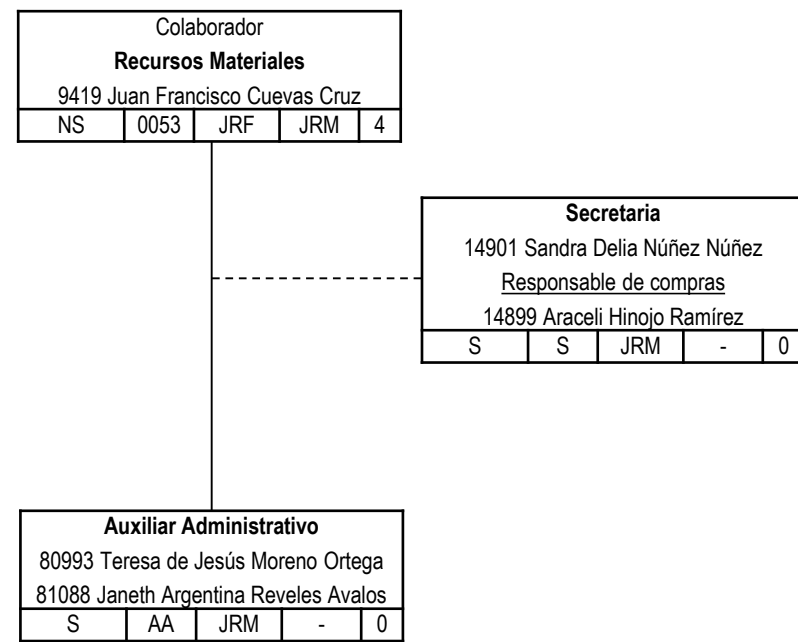

Unidad: **ADMINISTRACIÓN CENTRAL**

DEPENDENCIA: **HOSPITAL GENERAL DE TORREÓN**

Jefe de Departamento				
Jefe de Recursos Humanos				
81238 Renata Acevedo López				
NS	MG3	SSA	JRH	28

Secretaria				
80776 Deysi Domínguez Castañeda				
80905 María Ascensión Mireles Núñez				
S	S	JRH	-	0

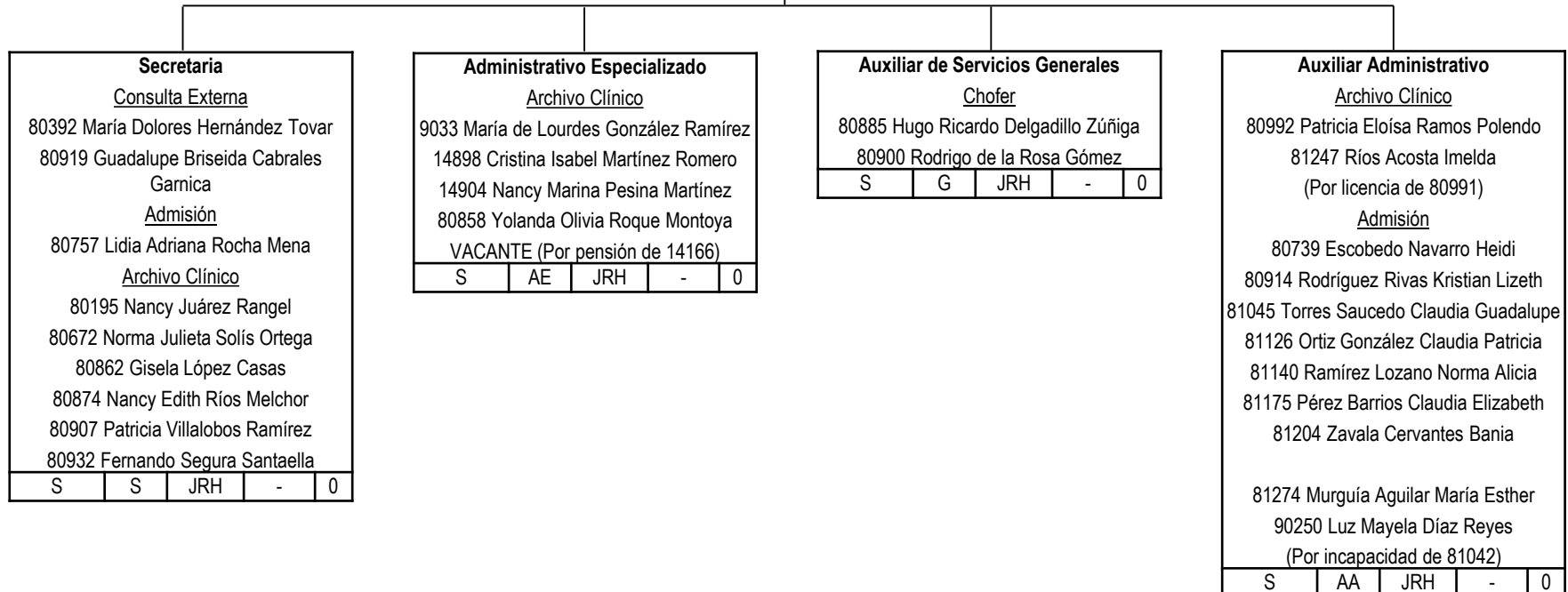

Unidad: **ADMINISTRACIÓN CENTRAL**

DEPENDENCIA: **HOSPITAL GENERAL DE TORREÓN**

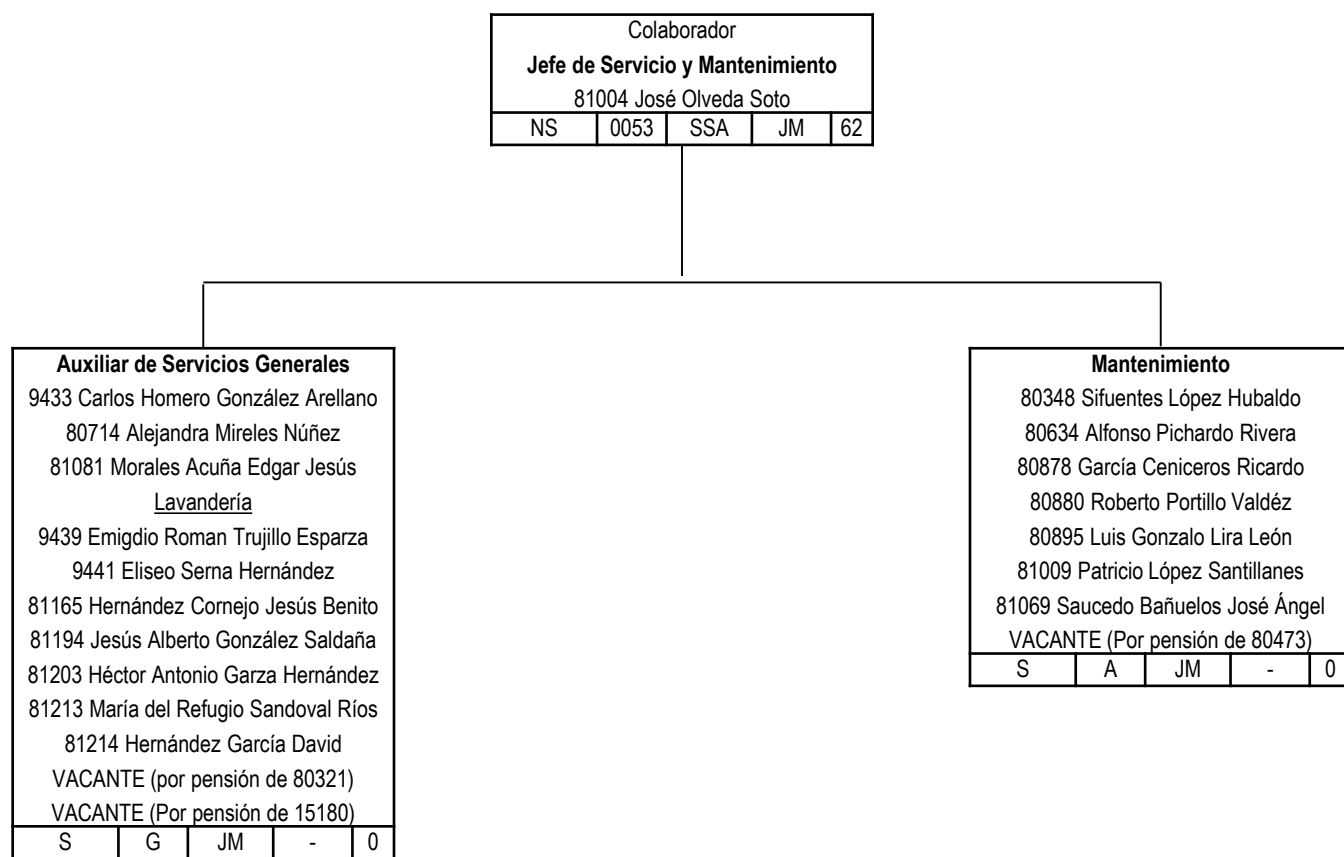

Unidad: **ADMINISTRACIÓN CENTRAL**

DEPENDENCIA: **HOSPITAL GENERAL DE TORREÓN**

